

# BONUS INDUSTRIAL LUMINAIRES

## BONUS ENDÜSTRİYEL ARMATÜRLERİ



### GENERAL INFORMATION

#### GENEL ÖZELLİKLER

Recommended installation height	5m to 25m
Önerilen Montaj Yüksekliği	5m ile 25m
CE mark	Yes
CE sertifikası	
ROHS compliant	Yes
ROHS uyumu	
CCT	5000°K (Standard)
Renk Sıcaklığı	
CRI	> 80+
Renk Geri Verim İndeksi	
Power	108 Watt
Güç	
Luminaire Light Output	13.585 Lm
Armatür Işık Akısı	
Efficacy	126 Lm/W
Etkinlik Faktörü	
EEL	0.11
Enerji Verimliliği İndeksi	
Energy Efficiency Class	A++
Enerji Verimliliği Sınıfı	
Testing standard	EN 60598-1
Test Standartları	EN 60598-2-13 EN 62262 EN 60529 IEC TR 62778 LM 79-08
Warranty	5 Years
Garanti	5 Yıl

### MECHANICAL INFORMATION

#### MEKANİK BİLGİLER

Body	Aluminum Extrusion
Gövde	Alüminyum Enjeksiyon
Dimensions (mm)	700 x 151 x 142
Boyutlar(mm)	
IP	IP 66
Koruma Sınıfı	
Colour Options	Black RAL9005, GREY RAL9007, WHITE RAL9016
Renk Seçeneği	

### ELECTRICAL INFORMATION

#### ELEKTRİKSEL BİLGİLER

Input Voltage	185~265 VAC
Giriş Gerilimi (V)	
PF (Power Factor)	> 95
Güç Faktörü	
Dimmable Options	1-10V, TRIAC, DALI
Opsiyonlar	
Electromagnetic compatibility (EMC)	EN 55015:2013/A1:2015, EN 61000-3-2:2014, EN 61000-3-3:2013, EN61000-4-2,3,4,5,6,11, EN 61547:2009, EN62384, EN 62493:2015
Elektromanyetik Uyumluluk	

### FIELDS OF APPLICATION

#### UYGULAMA ALANLARI



Powered by Samsung LED  
Philips LED Driver



### OPTICAL INFORMATION

#### OPTİK ÖZELLİKLER

LED	Mid Power LED
Lens	LEDIL Stradella 16 in 1
LED Lifetime	60.000 Hours/Saat
LED Ömrü	
Beam Angles	30° - 60° - 90°-110°
Optik	
LED colour	2700°K-3000°K-4000°K-5000°K-6500°K
Temperature	
Renk Sıcaklığı	5000°K
(Standart)	

### BEAM ANGLE OPTIONS

#### LENS OPSİYONLARI

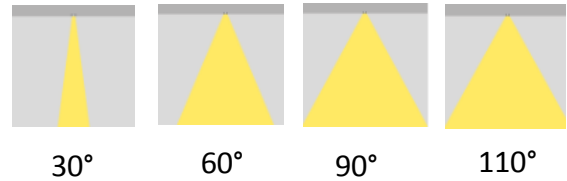

Please check LDC diagram options on page 5.  
Lütfen 5. sayfadaki LDC diyagram seçeneklerini kontrol edin.

## OTHER OPTIONS DİĞER OPSİYONLAR

Stock Code Stok Kodu	Product Name Ürün Adı	LED	LED Quantity Sayısı	Correlated Color Temperature (CCT) Renk Sıcaklığı	Color Rendering Index (CRI) Renkset Geri Verim İndeksi	Power (W) Güç	Light Output (lm) Lümen	Beam Angle Işık Açısı	Efficacy (lm/W) Etkinlik Faktörü	Dimension (mm) Boyut
150.25.4464	BONUS INDUSTRIAL 2548MPH 25W 30° BBSM	LM302D/SF	48	5000 °K	80+	26	3426	30°	132	200x151x142
150.25.4465	BONUS INDUSTRIAL 3548MPH 35W 30° BBSM	LM302D/SF	48	5000 °K	80+	34	4286	30°	126	200x151x142
150.25.4466	BONUS INDUSTRIAL 4048MPH 40W 30° BBSM	LM302D/SF	48	5000 °K	80+	41	4897	30°	119	200x151x142
150.25.4467	BONUS INDUSTRIAL 4848MPH 48W 30° BBSM	LM302D/SF	48	5000 °K	80+	47	5478	30°	117	200x151x142
150.25.4468	BONUS INDUSTRIAL 4380MPH 43W 30° BBSM	LM302D/SF	80	5000 °K	80+	43	5710	30°	133	370x151x142
150.25.4469	BONUS INDUSTRIAL 5580MPH 55W 30° BBSM	LM302D/SF	80	5000 °K	80+	54	6792	30°	126	370x151x142
150.25.4470	BONUS INDUSTRIAL 6580MPH 65W 30° BBSM	LM302D/SF	80	5000 °K	80+	64	7827	30°	122	370x151x142
150.25.4471	BONUS INDUSTRIAL 8080MPH 80W 30° BBSM	LM302D/SF	80	5000 °K	80+	79	9131	30°	116	600x151x142
150.25.4472	BONUS INDUSTRIAL 5096MPH 50W 30° BBSM	LM302D/SF	96	5000 °K	80+	52	6852	30°	132	370x151x142
150.25.4473	BONUS INDUSTRIAL 6596MPH 65W 30° BBSM	LM302D/SF	96	5000 °K	80+	65	8151	30°	125	370x151x142
150.25.4474	BONUS INDUSTRIAL 8096MPH 80W 30° BBSM	LM302D/SF	96	5000 °K	80+	82	9793	30°	119	600x151x142
150.25.4475	BONUS INDUSTRIAL 9596MPH 95W 30° BBSM	LM302D/SF	96	5000 °K	80+	95	10957	30°	115	600x151x142
150.25.4476	BONUS INDUSTRIAL 85160MPH 85W 30° BBSM	LM302D/SF	160	5000 °K	80+	87	11421	30°	131	600x151x142
150.25.4477	BONUS INDUSTRIAL 110160MPH 110W 30° BBSM	LM302D/SF	160	5000 °K	80+	108	13585	30°	126	700x151x142
150.25.4478	BONUS INDUSTRIAL 130160MPH 130W 30° BBSM	LM302D/SF	160	5000 °K	80+	129	15654	30°	121	700x151x142
150.25.4479	BONUS INDUSTRIAL 160160MPH 160W 30° BBSM	LM302D/SF	160	5000 °K	80+	158	18261	30°	116	700x151x142
150.25.4480	BONUS INDUSTRIAL 105192MPH 105W 30° BBSM	LM302D/SF	192	5000 °K	80+	104	13708	30°	132	700x151x142
150.25.4481	BONUS INDUSTRIAL 130192MPH 130W 30° BBSM	LM302D/SF	192	5000 °K	80+	129	16301	30°	126	700x151x142
150.25.4482	BONUS INDUSTRIAL 165192MPH 165W 30° BBSM	LM302D/SF	192	5000 °K	80+	163	19586	30°	120	700x151x142
150.25.4483	BONUS INDUSTRIAL 190192MPH 190W 30° BBSM	LM302D/SF	192	5000 °K	80+	190	21915	30°	115	700x151x142

Stock Code Stok Kodu	Product Name Ürün Adı	LED	LED Quantity Sayısı	Correlated Color Temperature (CCT) Renk Sıcaklığı	Color Rendering Index (CRI) Renkset Geri Verim İndeksi	Power (W) Güç	Light Output (lm) Lümen	Beam Angle Işık Açısı	Efficacy (lm/W) Etkinlik Faktörü	Dimension (mm) Boyut
150.25.4484	BONUS INDUSTRIAL 2548MPH 25W 60° BBSM	LM302D/SF	48	5000 °K	80+	26	3426	60°	132	200x151x142
150.25.4485	BONUS INDUSTRIAL 3548MPH 35W 60° BBSM	LM302D/SF	48	5000 °K	80+	34	4286	60°	126	200x151x142
150.25.4486	BONUS INDUSTRIAL 4048MPH 40W 60° BBSM	LM302D/SF	48	5000 °K	80+	41	4897	60°	119	200x151x142
150.25.4487	BONUS INDUSTRIAL 4848MPH 48W 60° BBSM	LM302D/SF	48	5000 °K	80+	47	5478	60°	117	200x151x142
150.25.4488	BONUS INDUSTRIAL 4380MPH 43W 60° BBSM	LM302D/SF	80	5000 °K	80+	43	5710	60°	133	370x151x142
150.25.4489	BONUS INDUSTRIAL 5580MPH 55W 60° BBSM	LM302D/SF	80	5000 °K	80+	54	6792	60°	126	370x151x142
150.25.4490	BONUS INDUSTRIAL 6580MPH 65W 60° BBSM	LM302D/SF	80	5000 °K	80+	64	7827	60°	122	370x151x142
150.25.4491	BONUS INDUSTRIAL 8080MPH 80W 60° BBSM	LM302D/SF	80	5000 °K	80+	79	9131	60°	116	600x151x142
150.25.4492	BONUS INDUSTRIAL 5096MPH 50W 60° BBSM	LM302D/SF	96	5000 °K	80+	52	6852	60°	132	370x151x142
150.25.4493	BONUS INDUSTRIAL 6596MPH 65W 60° BBSM	LM302D/SF	96	5000 °K	80+	65	8151	60°	125	370x151x142
150.25.4494	BONUS INDUSTRIAL 8096MPH 80W 60° BBSM	LM302D/SF	96	5000 °K	80+	82	9793	60°	119	600x151x142
150.25.4495	BONUS INDUSTRIAL 9596MPH 95W 60° BBSM	LM302D/SF	96	5000 °K	80+	95	10957	60°	115	600x151x142
150.25.4496	BONUS INDUSTRIAL 85160MPH 85W 60° BBSM	LM302D/SF	160	5000 °K	80+	87	11421	60°	131	600x151x142
150.25.4497	BONUS INDUSTRIAL 110160MPH 110W 60° BBSM	LM302D/SF	160	5000 °K	80+	108	13585	60°	126	700x151x142
150.25.4498	BONUS INDUSTRIAL 130160MPH 130W 60° BBSM	LM302D/SF	160	5000 °K	80+	129	15654	60°	121	700x151x142
150.25.4499	BONUS INDUSTRIAL 160160MPH 160W 60° BBSM	LM302D/SF	160	5000 °K	80+	158	18261	60°	116	700x151x142
150.25.4500	BONUS INDUSTRIAL 105192MPH 105W 60° BBSM	LM302D/SF	192	5000 °K	80+	104	13708	60°	132	700x151x142
150.25.4501	BONUS INDUSTRIAL 130192MPH 130W 60° BBSM	LM302D/SF	192	5000 °K	80+	129	16301	60°	126	700x151x142
150.25.4502	BONUS INDUSTRIAL 165192MPH 165W 60° BBSM	LM302D/SF	192	5000 °K	80+	163	19586	60°	120	700x151x142
150.25.4503	BONUS INDUSTRIAL 190192MPH 190W 60° BBSM	LM302D/SF	192	5000 °K	80+	190	21915	60°	115	700x151x142

Stock Code Stok Kodu	Product Name Ürün Adı	LED	LED Quantity Sayısı	Correlated Color Temperature (CCT) Renk Sıcaklığı	Color Rendering Index (CRI) Renksel Geri Verim İndeksi	Power (W) Güç	Light Output (lm) Lümen	Beam Angle Işık Açısı	Efficacy (lm/W) Etkinlik Faktörü	Dimension (mm) Boyut
150.25.4504	BONUS INDUSTRIAL 2548MPH 25W 90° BBSM	LM302D/SF	48	5000 °K	80+	26	3426	90°	132	200x151x142
150.25.4505	BONUS INDUSTRIAL 3548MPH 35W 90° BBSM	LM302D/SF	48	5000 °K	80+	34	4286	90°	126	200x151x142
150.25.4506	BONUS INDUSTRIAL 4048MPH 40W 90° BBSM	LM302D/SF	48	5000 °K	80+	41	4897	90°	119	200x151x142
150.25.4507	BONUS INDUSTRIAL 4848MPH 48W 90° BBSM	LM302D/SF	48	5000 °K	80+	47	5478	90°	117	200x151x142
150.25.4508	BONUS INDUSTRIAL 4380MPH 43W 90° BBSM	LM302D/SF	80	5000 °K	80+	43	5710	90°	133	370x151x142
150.25.4509	BONUS INDUSTRIAL 5580MPH 55W 90° BBSM	LM302D/SF	80	5000 °K	80+	54	6792	90°	126	370x151x142
150.25.4510	BONUS INDUSTRIAL 6580MPH 65W 90° BBSM	LM302D/SF	80	5000 °K	80+	64	7827	90°	122	370x151x142
150.25.4511	BONUS INDUSTRIAL 8080MPH 80W 90° BBSM	LM302D/SF	80	5000 °K	80+	79	9131	90°	116	600x151x142
150.25.4512	BONUS INDUSTRIAL 5096MPH 50W 90° BBSM	LM302D/SF	96	5000 °K	80+	52	6852	90°	132	370x151x142
150.25.4513	BONUS INDUSTRIAL 6596MPH 65W 90° BBSM	LM302D/SF	96	5000 °K	80+	65	8151	90°	125	370x151x142
150.25.4514	BONUS INDUSTRIAL 8096MPH 80W 90° BBSM	LM302D/SF	96	5000 °K	80+	82	9793	90°	119	600x151x142
150.25.4515	BONUS INDUSTRIAL 9596MPH 95W 90° BBSM	LM302D/SF	96	5000 °K	80+	95	10957	90°	115	600x151x142
150.25.4516	BONUS INDUSTRIAL 85160MPH 85W 90° BBSM	LM302D/SF	160	5000 °K	80+	87	11421	90°	131	600x151x142
150.25.4517	BONUS INDUSTRIAL 110160MPH 110W 90° BBSM	LM302D/SF	160	5000 °K	80+	108	13585	90°	126	700x151x142
150.25.4518	BONUS INDUSTRIAL 130160MPH 130W 90° BBSM	LM302D/SF	160	5000 °K	80+	129	15654	90°	121	700x151x142
150.25.4519	BONUS INDUSTRIAL 160160MPH 160W 90° BBSM	LM302D/SF	160	5000 °K	80+	158	18261	90°	116	700x151x142
150.25.4520	BONUS INDUSTRIAL 105192MPH 105W 90° BBSM	LM302D/SF	192	5000 °K	80+	104	13708	90°	132	700x151x142
150.25.4521	BONUS INDUSTRIAL 130192MPH 130W 90° BBSM	LM302D/SF	192	5000 °K	80+	129	16301	90°	126	700x151x142
150.25.4522	BONUS INDUSTRIAL 165192MPH 165W 90° BBSM	LM302D/SF	192	5000 °K	80+	163	19586	90°	120	700x151x142
150.25.4523	BONUS INDUSTRIAL 190192MPH 190W 90° BBSM	LM302D/SF	192	5000 °K	80+	190	21915	90°	115	700x151x142

Stock Code Stok Kodu	Product Name Ürün Adı	LED	LED Quantity Sayısı	Correlated Color Temperature (CCT) Renk Sıcaklığı	Color Rendering Index (CRI) Renksel Geri Verim İndeksi	Power (W) Güç	Light Output (lm) Lümen	Beam Angle Işık Açısı	Efficacy (lm/W) Etkinlik Faktörü	Dimension (mm) Boyut
150.25.4524	BONUS INDUSTRIAL 2548MPL 25W 30° BBSM	LM282B+/SB	48	5000 °K	80+	26	2972	30°	114	200x151x142
150.25.4525	BONUS INDUSTRIAL 3548MPL 35W 30° BBSM	LM282B+/SB	48	5000 °K	80+	35	3671	30°	105	200x151x142
150.25.4526	BONUS INDUSTRIAL 4048MPL 40W 30° BBSM	LM282B+/SB	48	5000 °K	80+	41	4150	30°	101	200x151x142
150.25.4527	BONUS INDUSTRIAL 4848MPL 48W 30° BBSM	LM282B+/SB	48	5000 °K	80+	48	4589	30°	96	200x151x142
150.25.4528	BONUS INDUSTRIAL 4580MPL 45W 30° BBSM	LM282B+/SB	80	5000 °K	80+	44	4952	30°	113	370x151x142
150.25.4529	BONUS INDUSTRIAL 5580MPL 55W 30° BBSM	LM282B+/SB	80	5000 °K	80+	54	5839	30°	108	370x151x142
150.25.4530	BONUS INDUSTRIAL 6580MPL 65W 30° BBSM	LM282B+/SB	80	5000 °K	80+	65	6658	30°	102	370x151x142
150.25.4531	BONUS INDUSTRIAL 8080MPL 80W 30° BBSM	LM282B+/SB	80	5000 °K	80+	80	7649	30°	96	600x151x142
150.25.4532	BONUS INDUSTRIAL 5396MPL 53W 30° BBSM	LM282B+/SB	96	5000 °K	80+	53	5942	30°	112	370x151x142
150.25.4533	BONUS INDUSTRIAL 6596MPL 65W 30° BBSM	LM282B+/SB	96	5000 °K	80+	65	7007	30°	108	370x151x142
150.25.4534	BONUS INDUSTRIAL 8396MPL 83W 30° BBSM	LM282B+/SB	96	5000 °K	80+	83	8299	30°	100	600x151x142
150.25.4535	BONUS INDUSTRIAL 9596MPL 95W 30° BBSM	LM282B+/SB	96	5000 °K	80+	96	9179	30°	96	600x151x142
150.25.4536	BONUS INDUSTRIAL 88160MPL 88W 30° BBSM	LM282B+/SB	160	5000 °K	80+	88	9904	30°	113	600x151x142
150.25.4537	BONUS INDUSTRIAL 110160MPL 110W 30° BBSM	LM282B+/SB	160	5000 °K	80+	109	11677	30°	107	700x151x142
150.25.4538	BONUS INDUSTRIAL 130160MPL 130W 30° BBSM	LM282B+/SB	160	5000 °K	80+	130	13316	30°	102	700x151x142
150.25.4539	BONUS INDUSTRIAL 160160MPL 160W 30° BBSM	LM282B+/SB	160	5000 °K	80+	160	15298	30°	96	700x151x142
150.25.4540	BONUS INDUSTRIAL 105192MPL 105W 30° BBSM	LM282B+/SB	192	5000 °K	80+	105	11885	30°	113	700x151x142
150.25.4541	BONUS INDUSTRIAL 130192MPL 130W 30° BBSM	LM282B+/SB	192	5000 °K	80+	130	14013	30°	108	700x151x142
150.25.4542	BONUS INDUSTRIAL 165192MPL 165W 30° BBSM	LM282B+/SB	192	5000 °K	80+	165	16599	30°	101	700x151x142
150.25.4543	BONUS INDUSTRIAL 192192MPL 192W 30° BBSM	LM282B+/SB	192	5000 °K	80+	192	18358	30°	96	700x151x142

Stock Code Stok Kodu	Product Name Ürün Adı	LED	LED Quantity Sayısı	Correlated Color Temperature (CCT) Renk Sıcaklığı	Color Rendering Index (CRI) Renksel Geri Verim İndeksi	Power (W) Güç	Light Output (lm) Lümen	Beam Angle Işık Açısı	Efficacy (lm/W) Etkinlik Faktörü	Dimension (mm) Boyut
150.25.4544	BONUS INDUSTRIAL 2548MPL 25W 60° BBSM	LM282B+/SB	48	5000 °K	80+	26	2972	60°	114	200x151x142
150.25.4545	BONUS INDUSTRIAL 3548MPL 35W 60° BBSM	LM282B+/SB	48	5000 °K	80+	35	3671	60°	105	200x151x142
150.25.4546	BONUS INDUSTRIAL 4048MPL 40W 60° BBSM	LM282B+/SB	48	5000 °K	80+	41	4150	60°	101	200x151x142
150.25.4547	BONUS INDUSTRIAL 4848MPL 48W 60° BBSM	LM282B+/SB	48	5000 °K	80+	48	4589	60°	96	200x151x142
150.25.4548	BONUS INDUSTRIAL 4580MPL 45W 60° BBSM	LM282B+/SB	80	5000 °K	80+	44	4952	60°	113	370x151x142
150.25.4549	BONUS INDUSTRIAL 5580MPL 55W 60° BBSM	LM282B+/SB	80	5000 °K	80+	54	5839	60°	108	370x151x142
150.25.4550	BONUS INDUSTRIAL 6580MPL 65W 60° BBSM	LM282B+/SB	80	5000 °K	80+	65	6658	60°	102	370x151x142
150.25.4551	BONUS INDUSTRIAL 8080MPL 80W 60° BBSM	LM282B+/SB	80	5000 °K	80+	80	7649	60°	96	600x151x142
150.25.4552	BONUS INDUSTRIAL 5396MPL 53W 60° BBSM	LM282B+/SB	96	5000 °K	80+	53	5942	60°	112	370x151x142
150.25.4553	BONUS INDUSTRIAL 6596MPL 65W 60° BBSM	LM282B+/SB	96	5000 °K	80+	65	7007	60°	108	370x151x142
150.25.4554	BONUS INDUSTRIAL 8396MPL 83W 60° BBSM	LM282B+/SB	96	5000 °K	80+	83	8299	60°	100	600x151x142
150.25.4555	BONUS INDUSTRIAL 9596MPL 95W 60° BBSM	LM282B+/SB	96	5000 °K	80+	96	9179	60°	96	600x151x142
150.25.4556	BONUS INDUSTRIAL 88160MPL 88W 60° BBSM	LM282B+/SB	160	5000 °K	80+	88	9904	60°	113	600x151x142
150.25.4557	BONUS INDUSTRIAL 110160MPL 110W 60° BBSM	LM282B+/SB	160	5000 °K	80+	109	11677	60°	107	700x151x142
150.25.4559	BONUS INDUSTRIAL 130160MPL 130W 60° BBSM	LM282B+/SB	160	5000 °K	80+	130	13316	60°	102	700x151x142
150.25.4560	BONUS INDUSTRIAL 160160MPL 160W 60° BBSM	LM282B+/SB	160	5000 °K	80+	160	15298	60°	96	700x151x142
150.25.4561	BONUS INDUSTRIAL 105192MPL 105W 60° BBSM	LM282B+/SB	192	5000 °K	80+	105	11885	60°	113	700x151x142
150.25.4562	BONUS INDUSTRIAL 130192MPL 130W 60° BBSM	LM282B+/SB	192	5000 °K	80+	130	14013	60°	108	700x151x142
150.25.4563	BONUS INDUSTRIAL 165192MPL 165W 60° BBSM	LM282B+/SB	192	5000 °K	80+	165	16599	60°	101	700x151x142
150.25.4564	BONUS INDUSTRIAL 192192MPL 192W 60° BBSM	LM282B+/SB	192	5000 °K	80+	192	18358	60°	96	700x151x142

Stock Code Stok Kodu	Product Name Ürün Adı	LED	LED Quantity Sayısı	Correlated Color Temperature (CCT) Renk Sıcaklığı	Color Rendering Index (CRI) Renksel Geri Verim İndeksi	Power (W) Güç	Light Output (lm) Lümen	Beam Angle Işık Açısı	Efficacy (lm/W) Etkinlik Faktörü	Dimension (mm) Boyut
150.25.4558	BONUS INDUSTRIAL 2548MPL 25W 90° BBSM	LM282B+/SB	48	5000 °K	80+	26	2972	90°	114	200x151x142
150.25.4565	BONUS INDUSTRIAL 3548MPL 35W 90° BBSM	LM282B+/SB	48	5000 °K	80+	35	3671	90°	105	200x151x142
150.25.4566	BONUS INDUSTRIAL 4048MPL 40W 90° BBSM	LM282B+/SB	48	5000 °K	80+	41	4150	90°	101	200x151x142
150.25.4567	BONUS INDUSTRIAL 4848MPL 48W 90° BBSM	LM282B+/SB	48	5000 °K	80+	48	4589	90°	96	200x151x142
150.25.4568	BONUS INDUSTRIAL 4580MPL 45W 90° BBSM	LM282B+/SB	80	5000 °K	80+	44	4952	90°	113	370x151x142
150.25.4569	BONUS INDUSTRIAL 5580MPL 55W 90° BBSM	LM282B+/SB	80	5000 °K	80+	54	5839	90°	108	370x151x142
150.25.4570	BONUS INDUSTRIAL 6580MPL 65W 90° BBSM	LM282B+/SB	80	5000 °K	80+	65	6658	90°	102	370x151x142
150.25.4571	BONUS INDUSTRIAL 8080MPL 80W 90° BBSM	LM282B+/SB	80	5000 °K	80+	80	7649	90°	96	600x151x142
150.25.4572	BONUS INDUSTRIAL 5396MPL 53W 90° BBSM	LM282B+/SB	96	5000 °K	80+	53	5942	90°	112	370x151x142
150.25.4573	BONUS INDUSTRIAL 6596MPL 65W 90° BBSM	LM282B+/SB	96	5000 °K	80+	65	7007	90°	108	370x151x142
150.25.4574	BONUS INDUSTRIAL 8396MPL 83W 90° BBSM	LM282B+/SB	96	5000 °K	80+	83	8299	90°	100	600x151x142
150.25.4575	BONUS INDUSTRIAL 9596MPL 95W 90° BBSM	LM282B+/SB	96	5000 °K	80+	96	9179	90°	96	600x151x142
150.25.4576	BONUS INDUSTRIAL 88160MPL 88W 90° BBSM	LM282B+/SB	160	5000 °K	80+	88	9904	90°	113	600x151x142
150.25.4577	BONUS INDUSTRIAL 110160MPL 110W 90° BBSM	LM282B+/SB	160	5000 °K	80+	109	11677	90°	107	700x151x142
150.25.4578	BONUS INDUSTRIAL 130160MPL 130W 90° BBSM	LM282B+/SB	160	5000 °K	80+	130	13316	90°	102	700x151x142
150.25.4579	BONUS INDUSTRIAL 160160MPL 160W 90° BBSM	LM282B+/SB	160	5000 °K	80+	160	15298	90°	96	700x151x142
150.25.4580	BONUS INDUSTRIAL 105192MPL 105W 90° BBSM	LM282B+/SB	192	5000 °K	80+	105	11885	90°	113	700x151x142
150.25.4581	BONUS INDUSTRIAL 130192MPL 130W 90° BBSM	LM282B+/SB	192	5000 °K	80+	130	14013	90°	108	700x151x142
150.25.4582	BONUS INDUSTRIAL 165192MPL 165W 90° BBSM	LM282B+/SB	192	5000 °K	80+	165	16599	90°	101	700x151x142
150.25.4583	BONUS INDUSTRIAL 192192MPL 192W 90° BBSM	LM282B+/SB	192	5000 °K	80+	192	18358	90°	96	700x151x142

## LIGHT DISTRIBUTION CURVE OPTIONS IŞIK DAĞILIM EĞRİSİ SEÇENEKLERİ

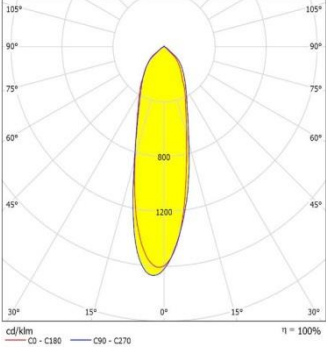

Beam Angle : 30°  
Optik : 30°

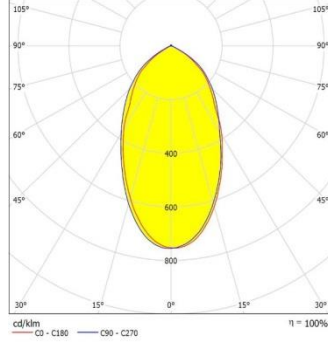

Beam Angle : 60°  
Optik : 60°

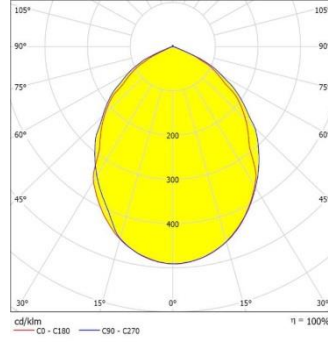

Beam Angle : 90°  
Optik : 90°

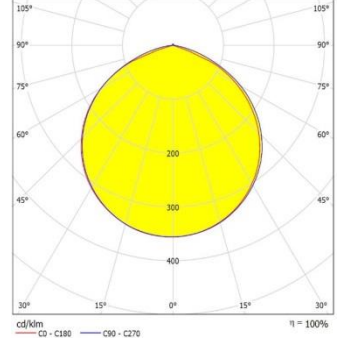

Beam Angle : 110°  
Optik : 110°

## DIMENSIONS BOYUTLAR

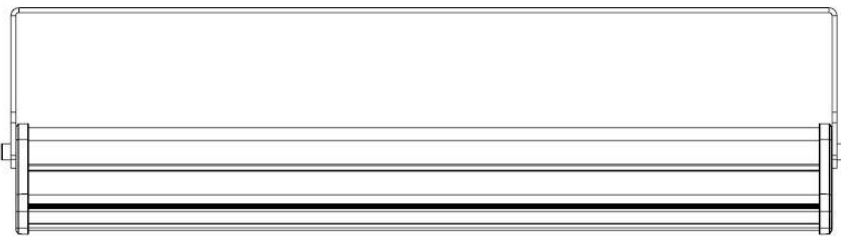
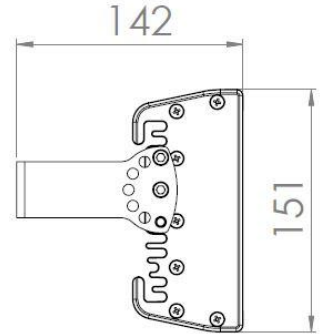
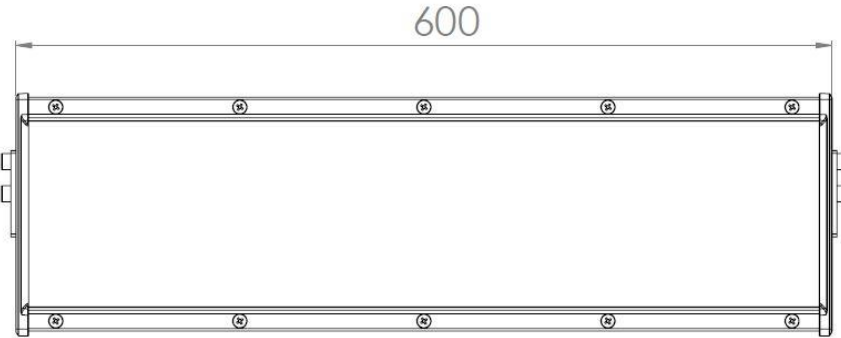

\* This is only reference and belong to 150.25.4496. Please refer to the other dimensions on product table.

\* Bu sadece referanstır ve 150.25.4496'ya aittir. Lütfen ürün tablosunda diğer ölçülere bakınız.

**CERTIFICATES  
SERTİFİKALAR**



**LVD EMC CE**



# fotonik™

*Creates Intelligent Photons*



UVA



UVB

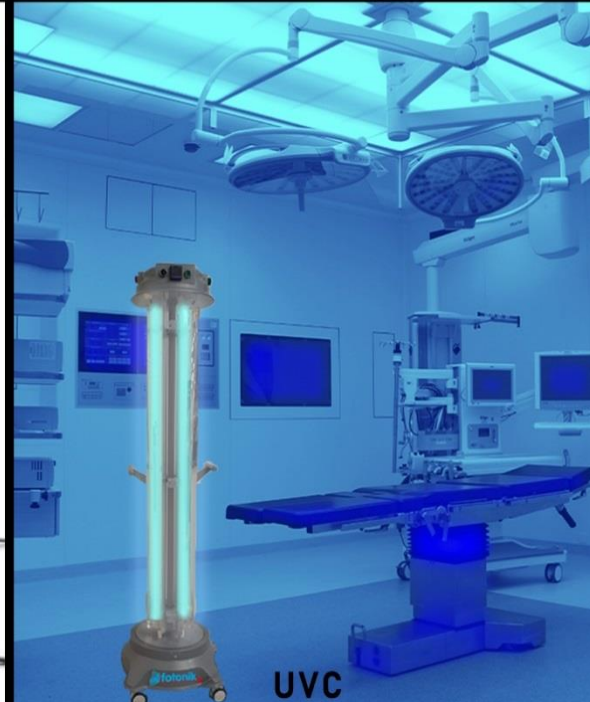

UVC



9001:2015



14001:2015



45001:2018



13485:2016



Ar-Ge/R&D: A. Veysel Bulv. ERU TGB 4. Bina, No: 67-3/41, M.Gazi/KAYSERİ

Fabrika/Factory: Anbar Mah. 2973. Sokak A2 Blok No:11/D, M.Gazi/KAYSERİ

+90 352 502 02 50

+90 555 090 12 38

**İstanbul:** +90 212 401 98 38  
+90 542 532 47 16  
istanbul@fotonik.com.tr

**Ankara:** +90 312 335 25 94  
+90 530 868 35 59  
ankara@fotonik.com.tr

**İzmir:** +90 232 570 01 18  
+90 544 344 40 31  
izmir@fotonik.com.tr

**Bursa:** +90 224 441 00 68  
+90 533 442 64 44  
bursa@fotonik.com.tr

**Antalya:** +90 352 502 02 50  
+90 541 470 16 39  
antalya@fotonik.com.tr



www.fotonik.com.tr