

LED BAR-DMX 512

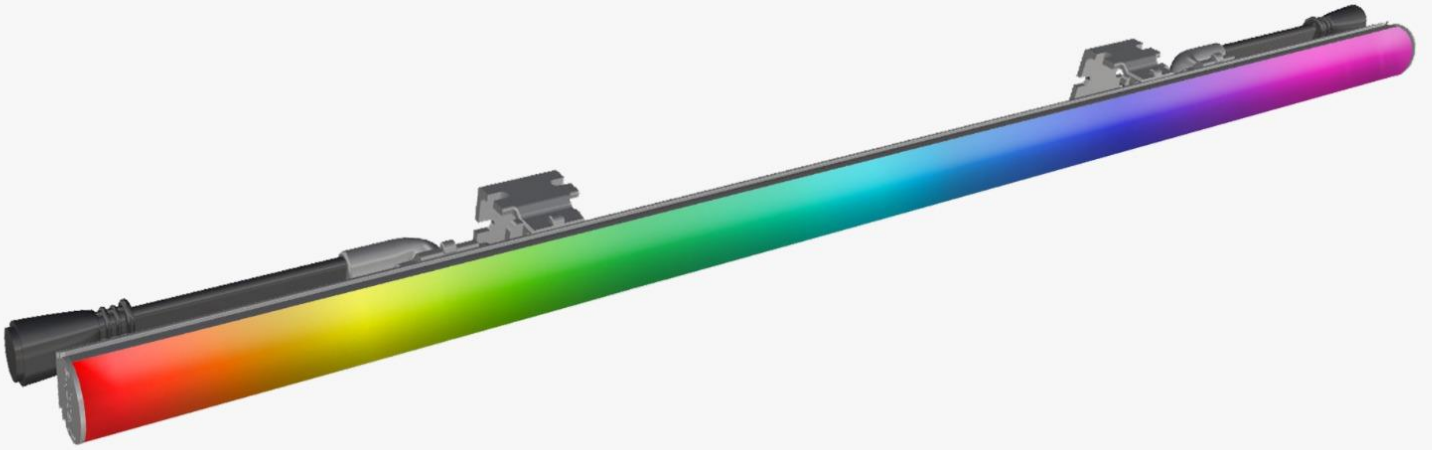

Yıldırım Beyazıt Mah. Aşık Veysel Bulv. ERU TGB 4.Bina, No:67-3/41, 38039 Melikgazi/KAYSERİ
Fabrika: Anbar Mah. 2973. Sk. A2 Blok, No: 11/D, Melikgazi/KAYSERİ

info@fotonik.com.tr
satis@fotonik.com.tr

Tel: +90 (533) 479 98 19
Tel-Fax: 0 (352) 502 02 50

PAGE : 1/7



GENERAL SPECIFICATION

LED CHIP BRANDS / TYPE	NICHIA, CREE / 3232 SMD, 3CHIPS IN 1 LED
LIGHT COLOR / DEPTH	RGB / 16 MILLION COLORS
CONTROL	DMX512A
ADDRESSING	AUTOMATIC / MANUEL
LED/METER	36PCS/M
PIXEL PITCH	166 MM
LED/PIXEL	6 PCS
PIXEL/METER	6 PCS
INPUT VOLTAGE	24VDC
POWER CONSUMPTION	8,5W/M (MAX. POWER)
MAX. LENGTH OF LINE	20 METERS
LED LIFESPAN	100.000 Hrs.
BEAM ANGLES	140°
BODY METARIAL / COLOR	UV PROTECTION POLYCARBONATE / GREY
DIFFUSER / TRANSPARENCY	UV PROTECTION POLYCARBONATE / %85 TRANSLUCENT
IP GRADE	IP67
OPERATING TEMPERATURE	-25°C TO 65°C
OPERATING HUMITIDY	≥5% -95% RH

MODELS

MODEL	NUMBER OF LEDs	NUMBER OF PIXELs	NUMBER OF CHANNELS	DIMENSIONS
LB-RGB 033	12	2	6	333X48X29.5 MM
LB-RGB 050	18	3	9	500X48X29.5 MM
LB-RGB 066	24	4	12	666X48X29.5 MM
LB-RGB 100	36	6	18	1000X48X29.5 MM
LB-RGB 150	54	9	27	1500X48X29.5 MM



DIMENSIONS

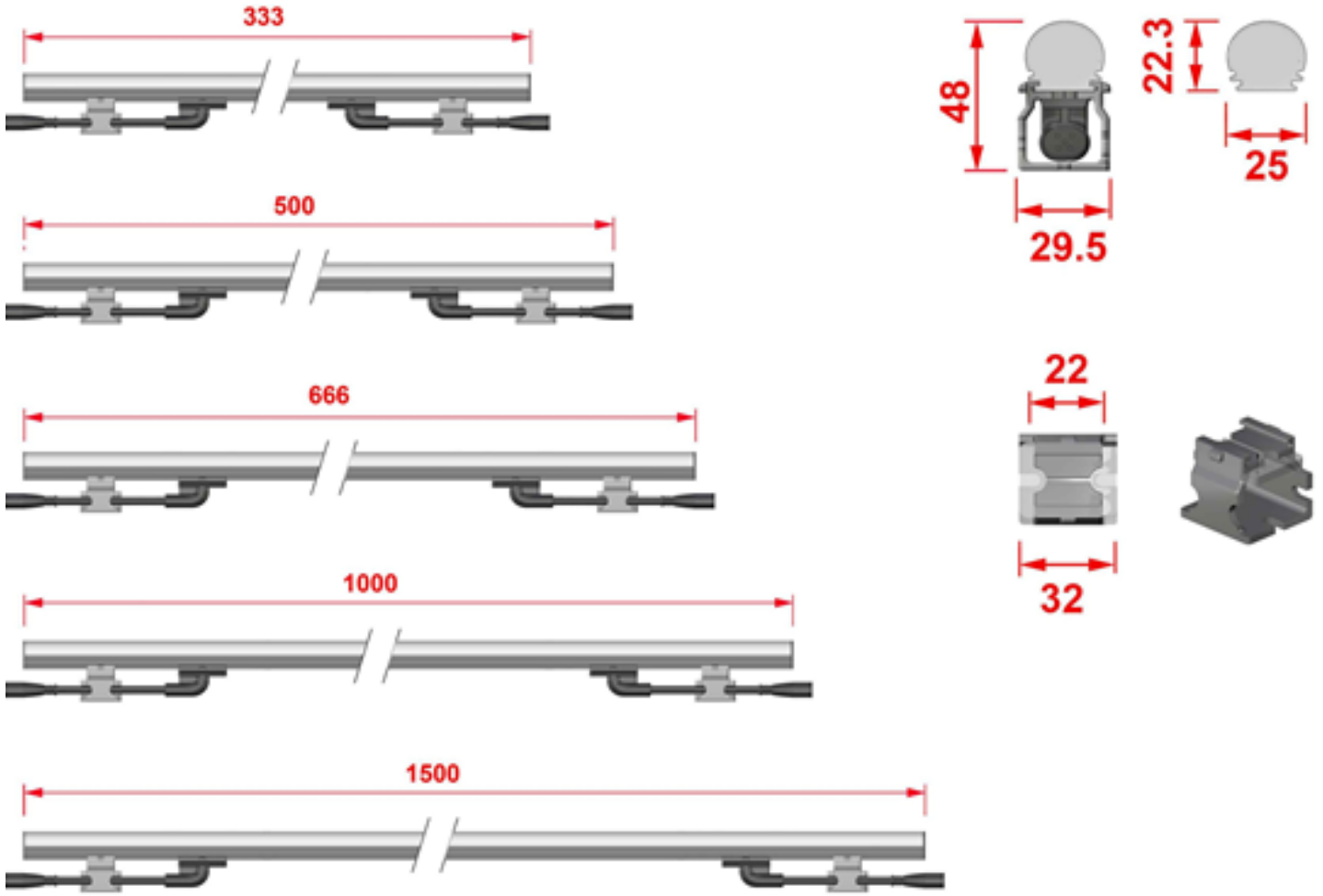

SCHEMATIC DIAGRAM

EXAMPLE #1

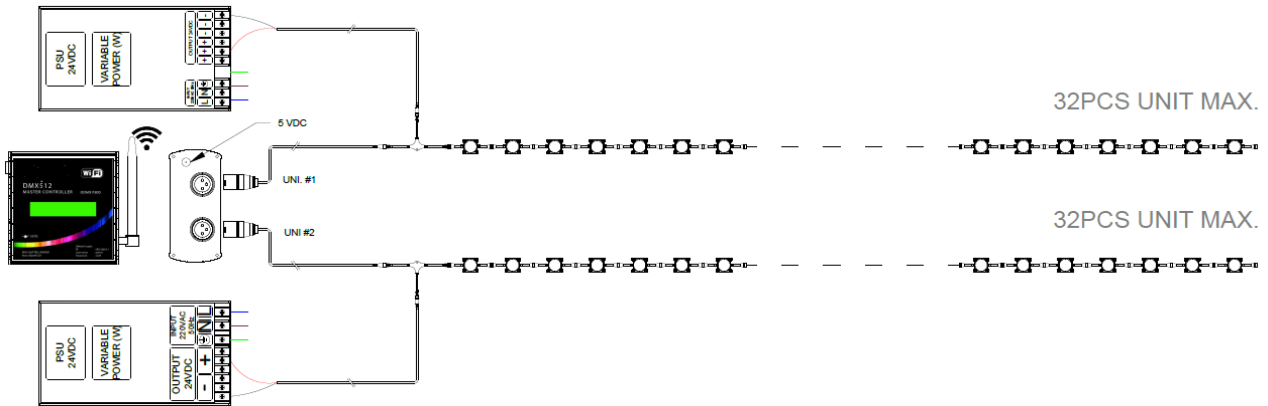



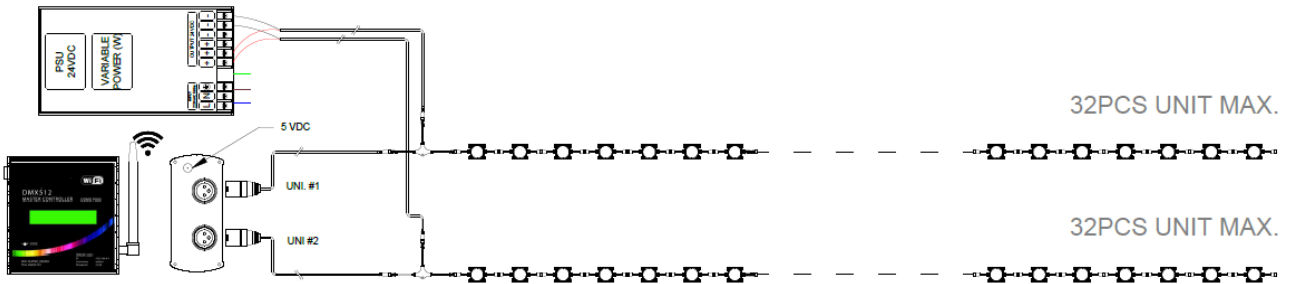

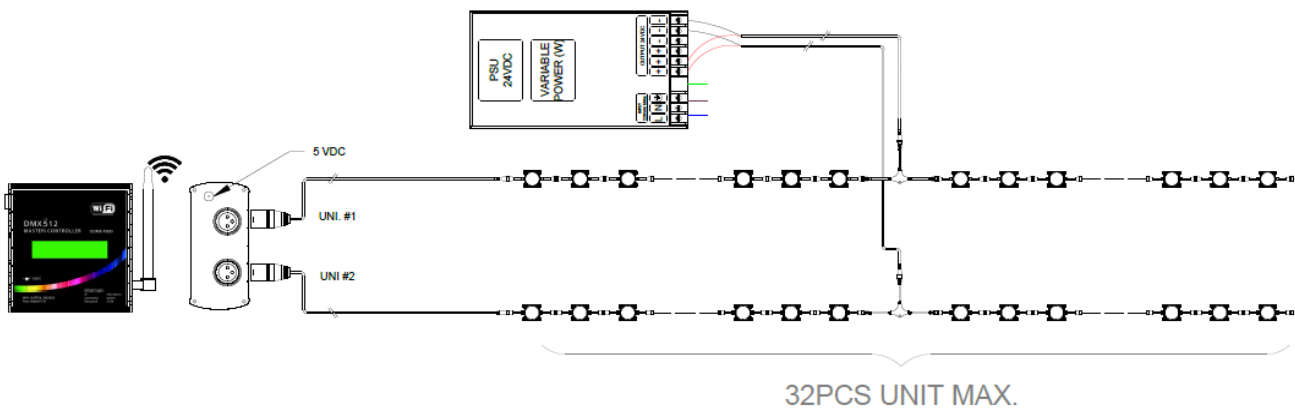

EXAMPLE #2







EXAMPLE #3



ACCESORIES (CABLES)

CABLE TYPE	SPECIFICATION
	OSC SOC5S-040C, SEAL CONNECTOR, MALE/ FEMALE, 5WIRE, (2x2.5+3x0.34mm ²), BLUE, GREY, 40cm, BODY (PC+PE), IP67
	OSC SOC5M-100C, SEAL CONNECTOR, MALE, 5WIRE, (2x2.5+3x0.34mm ²), BLUE, GREY, 100cm, BODY (PC+PE), IP67
	OSC SOC5F-100C, SEAL CONNECTOR, FEMALE, 5WIRE, (2x2.5+3x0.34mm ²), BLUE, GREY, 100cm, BODY (PC+PE), IP67
	OSC SOC5E-100C, SEAL CONNECTOR, MALE TO FEMALE, 5WIRE, (2x2.5+3x0.34mm ²), BLUE, GREY, 100cm, BODY (PC+PE), IP67
	OSC SOC5T2-005C, SEAL CONNECTOR, FEMALE TO 2 MALE, 5WIRE, (2x2.5+3x0.34mm ²), BLUE, GREY, 5cm, BODY (PC+PE), IP67
	ODC XLR3E-100C DMx CONNECTOR MALE TO FEMALE 3x0,22mm ² 100cm P+M IP20
	ODC XLR3F-100C DMx CONNECTOR FEMALE TO WIRE 3x0,22mm ² 100cm P+M IP20
	ODC XLR3M-100C DMx CONNECTOR MALE TO WIRE 3x0,22mm ² 100cm P+M IP20
	ODC XLR5E-100C DMx CONNECTOR MALE TO FEMALE 5x0,22mm ² 100cm P+M IP20
	ODC XLR5F-100C DMx CONNECTOR FEMALE TO WIRE 5x0,22mm ² 100cm P+M IP20
	ODC XLR5M-100C DMx CONNECTOR MALE TO WIRE 5x0,22mm ² 100cm P+M IP20

ACCESORIES (DMX MASTER CONTROLLERS)

GEAR TYPE	SPECIFICATION
	ODX S100A, BASIC, 1x512Ch, WiFi / WEB INTERFACE, STANDALONE 2 CONTROL BUTTON, NO SD CARD / 2MB, NO IR REMOTE, 1x3PIN XLR, ALU. WALL TYPE, 110x50x53mm, IP20
	ODX S200A, BASIC, 2x512Ch, WiFi / WEB INTERFACE, STANDALONE/LIVE, NO SD CARD / 2MB, IR REMOTE, 2x3PIN XLR, ALU. WALL TYPE, 110x50x53mm, IP20
	ODX P800A, PRO, 2x512Ch, WiFi / WEB INTERFACE, STANDALONE/LIVE, SD CARD 2GB, IR REMOTE, 2x3PIN XLR, ALU. WALL TYPE, 110x50x103mm, IP20
	CDMX GW4A, PRO, 4x512Ch, ETHERNET, LIVE, ALU. WALL TYPE, 190x40x115mm, IP20
	CDMX GW8A, PRO, 8x512Ch, ETHERNET, LIVE, ALU. WALL TYPE, 190x40x115mm, IP20